

Type **TW19**

WEH[®] Connector for pneumatic and oil-hydraulic pressure and function testing of components with female thread



General

DESCRIPTION



Features

- Connection in seconds
- No hand tightening required
- WEH® Jaw locking mechanism
- High-grade materials

The WEH® TW19 Quick connector is especially designed for sealing hydraulic components with female thread in high and low pressure applications. The clamping lever actuated connector safely grips into the test piece, even in case of high lateral forces, e.g. heavy or rigid hoses. The higher the test pressure the tighter the WEH® Connector will clamp itself into the thread of the test piece. The front o-ring reliably seals the connection and no additional clamping devices are required. Having only one seal in the interior of the connector, ease of maintenance is provided.

Application

Quick connector for pneumatic and oil-hydraulic pressure and function testing of components with female thread, e.g. hydraulic aggregates.

TECHNICAL DATA

Characteristics	Basic version
Max. allowable operating pressure PS	Vacuum up to 350 bar
Temperature range	+5 °C up to +80 °C
Leak rate	1×10^{-3} mbar x l/s
Actuation	Manual actuation via clamping lever
Material	Corrosion resistant stainless steel
Sealing material	Front seal of NBR

Other designs on request

Note: Please contact us when using corrosive media or water!

Example of use:



Ordering

ORDERING | WEH® TW19 Quick connector

approx. dimensions (mm)

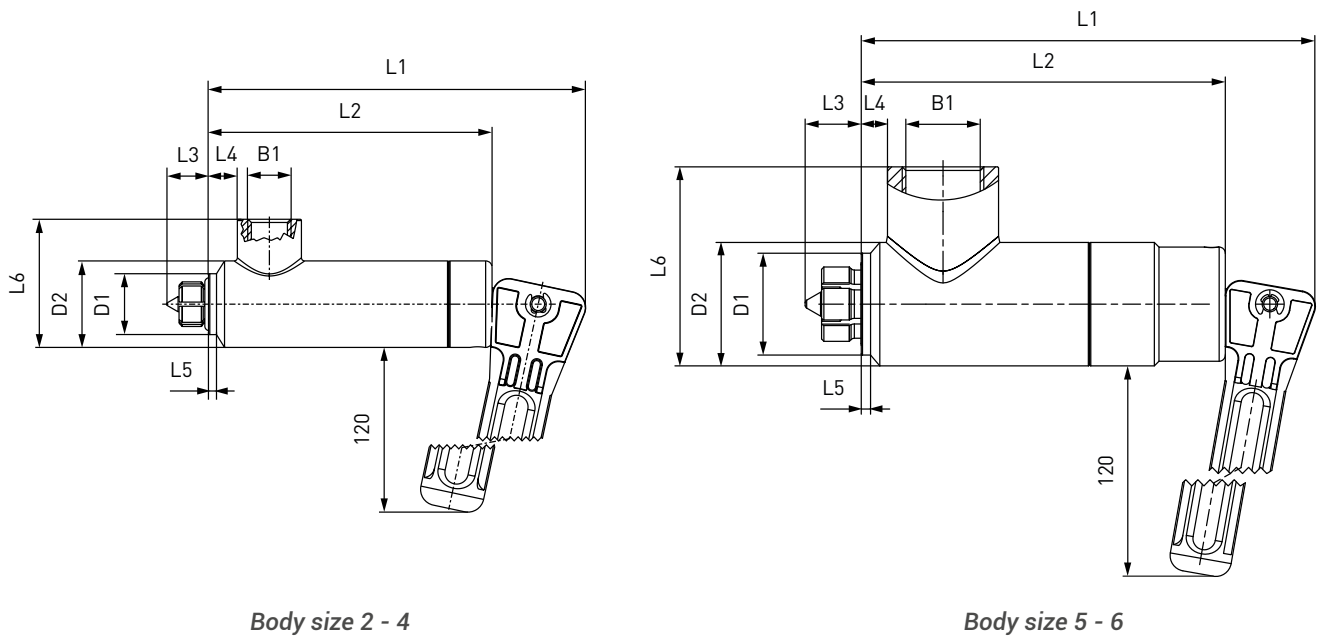

Body size 2 - 4

Body size 5 - 6

Body size	B1 (female thread)	D1	D1*	D2	D2*	L1	L2	L3	L4	L5	L5*	L6
2	G1/4"	19.0	20.5	27.0	27.0	118.0	88.5	13.0	9.0	2.5	5.0	40.0
3	G3/8"	23.0	26.0	32.0	32.0	131.0	101.5	16.0	9.5	2.0	4.0	50.0
4	G1/2"	27.0	29.0	37.0	37.0	131.0	101.5	17.0	8.0	3.0	4.0	55.0
5	G3/4"	33.0	40.5	40.0	45.0	146.0	117.0	19.5	8.0	3.0	8.0	69.0
6	G1"	40.0	46.5	49.0	49.0	170.0	140.0	17.0	18.0	3.0	8.0	74.0

* applies to SAE J1926

Metric ISO-thread to DIN 13 - acc. to DIN 3852 part 1, form X and Y

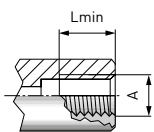

Part no.	Body size	Thread A (female thread)	Lmin*
C1-16484	2	M12x1.5	9.5
C1-16483	2	M14x1.5	9.5
C1-16590	3	M16x1.5	10.5
C1-16459	3	M18x1.5	10.5
C1-18404	4	M20x1.5	10.5
C1-16460	4	M22x1.5	10.5
C1-12860	5	M24x1.5	11.0
C1-17260	5	M26x1.5	11.0

* Lmin: minimum thread length
Other connection sizes on request

Ordering

Metric ISO thread to DIN 13 - acc. to ISO 6149-1

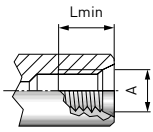

Part no.	Body size	Thread A (female thread)	Lmin*
C1-35915	2	M12x1.5	9.5
C1-14940	2	M14x1.5	9.5
C1-48588	3	M16x1.5	10.5
C1-35916	3	M18x1.5	10.5
C1-119114	4	M20x1.5	10.5
C1-33703	4	M22x1.5	10.5
C1-41186	5	M27x2.0	11.0

* Lmin: minimum thread length
Other connection sizes on request

Whitworth tube thread to DIN EN ISO 228-1 - acc. to DIN 3852 part 2, form X and Y

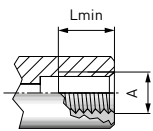

Part no.	Body size	Thread A (female thread)	Lmin*
C1-16494	2	G1/4"	9.5
C1-16493	3	G3/8"	10.5
C1-16888	4	G1/2"	10.5
C1-15161	5	G3/4"	11.0
C1-18191	6	G1"	12.5

* Lmin: minimum thread length
Other connection sizes on request

BSPT (tapered Whitworth tube thread) - acc. to DIN 3852 part 2, form X and Y

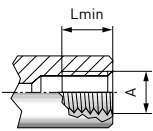

Part no.	Body size	Thread A (female thread)	Lmin*
C1-14544	2	BSPT 1/4"	9.5
C1-18648	3	BSPT 3/8"	10.5
C1-17275	4	BSPT 1/2"	10.5
C1-164842	5	BSPT 3/4"	11.0
C1-16180	6	BSPT 1"	12.5

* Lmin: minimum thread length
Other connection sizes on request

Ordering / Accessories

NPT thread (ANSI/ASME B1.20.1-1983) - acc. to SAE J476a

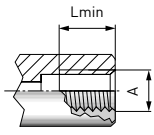

Part no.	Body size	Thread A (female thread)	Lmin*
C1-16565	2	NPT 1/4"	9.5
C1-44258	3	NPT 3/8"	10.5
C1-72165	4	NPT 1/2"	10.5
C1-164869	5	NPT 3/4"	11.0
C1-16874	6	NPT 1"	12.5

* Lmin: minimum thread length
Other connection sizes on request

SAE-O-Ring Boss - acc. to SAE J1926 / ISO 11926

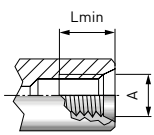

Part no.	Body size	Thread A (female thread)	Lmin*
C1-164843	2	UNF 1/2"-20	9.5
C1-16485	2	UNF 9/16"-18	9.5
C1-17618	3	UNF 3/4"-16	10.5
C1-18242	4	UNF 7/8"-14	10.5
C1-18394	5	UN 1 1/16"-12	11.0
C1-16461	6	UN 1 5/16"-12	11.0

* Lmin: minimum thread length
Other connection sizes on request

Other connection types on request.

Required information for ordering see page 7, catalog no. 35.

ACCESSORIES

The following accessories are available for the WEH® TW19 Quick connector:

Screw plug for plug version

If the WEH® Connector is used as a plug, the media inlet 'B1' can be sealed with a screw plug of stainless steel with an o-ring of NBR 70° Shore for high pressure range. It is recommended that the media compatibility of the seal be tested by the customer!



Part no.	Description	Connection (male thread)	Pressure range
W9330	Screw plug (high pressure)	G1/4"	0 - 350 bar
W9331	Screw plug (high pressure)	G3/8"	0 - 350 bar
W9332	Screw plug (high pressure)	G1/2"	0 - 350 bar
On request	Screw plug (high pressure)	G3/4"	0 - 350 bar
On request	Screw plug (high pressure)	G1"	0 - 350 bar

Technical explanations

TECHNICAL EXPLANATIONS

Abbreviations/Definitions

For explanation of abbreviations and definitions of terms see applicable Technical Appendix of the corresponding catalog or www.weh.com

Illustrations

The illustrations and/or images used in these data sheet are particularly provided for illustrative purposes only and may differ in some details from the actual product. For binding information, please refer to your individual orders.

Safe product selection

Our WEH® Products are designed to be operated by qualified professional users (insofar as WEH® Products are also designed to be operated by other users in individual cases, this is explicitly stated in the corresponding operating instructions). Please note that WEH does not know your system and therefore - also due to the large number of different potential applications of WEH® Products - cannot perform tests on all potential types of application. You alone are responsible for the selection, configuration and suitability of WEH® Products, especially according to the requirements of your system. Before purchasing WEH® Products, please particularly ensure that our products are compatible with your intended use, your performance data, your material and fluids, your system concept and your system limits according to our product specifications. Please also consider your technical and legal requirements for operation, handling and maintenance. The quality and safety of WEH® Products is our highest priority. For this reason, WEH® Products may not be used outside the specifications in the relevant data sheets and product descriptions. If you are not sure whether the WEH® Product is suitable for your system and intended use, please contact us in advance. We also strongly recommend that you refrain from using third-party spare parts or a combination of WEH® Products with unsuitable third-party products. You alone are responsible for reviewing the suitability of third-party products. WEH® Products and WEH® Spare parts comply with our quality and safety standards.

Service life

WEH® Products are generally products which may be subject to wear and fatigue during operation and depending on your individual application/use. For details - in particular regarding the corresponding minimum inspection and maintenance intervals - please refer to the respective operating instructions for the WEH® Product.

Explanation on the Pressure Equipment Directive

These WEH® Products are generally classified as pressure accessories in accordance with Article 2 (5) of the Pressure Equipment Directive 2014/68/EU and are considered to be similar to piping. These WEH® Products may not be used as safety accessories. Furthermore, it is pointed out, that these WEH® Products are designed and placed on the market in accordance with the requirements of Article 4 (3) of the Pressure Equipment Directive 2014/68/EU. The assessment with regard to a different classification can, however, be made on request.

External change management

WEH reserves the right to update, optimise and adjust its products continuously. This may result in corresponding changes of the product. Customers will be informed proactively or unsolicited by WEH only in individual cases about product updates, product optimisations and/or product adaptations that have been carried out. You are free to contact WEH at any time to request information about any product updates, product optimisations and/or product adjustments.

© All rights reserved, WEH GmbH Verbindungstechnik.

Any unauthorized copying, distribution or other use of the copyrighted content is strictly forbidden without the written consent of WEH GmbH Verbindungstechnik.

Upon transmission of a newer version of this document, all previous versions are no longer valid. In principle, the latest version of the document is valid. This can be found at www.weh.com.

Our General Terms and Conditions and the Agreement on Protection of Know-How and Quality Assurance (www.weh.com) shall apply to deliveries and other services, unless expressly agreed otherwise.

We do not accept any General Terms and Conditions of the purchaser.

WEH® is a registered trademark of WEH GmbH Verbindungstechnik.

» Contact

More questions? – Great! Don't hesitate to contact our experts.

Manufacturer:

WEH GmbH Precision Connectors

Josef-Henle-Str. 1
89257 Illertissen / Germany

Phone: +49 7303 9609-0

E-Mail: sales@weh.com

Website: www.weh.com